

BASO 1.5 / 2.5 / 4.0 T-BAR GRID surface

MOUNTING INSTRUCTIONS

DO NOT DISCARD!

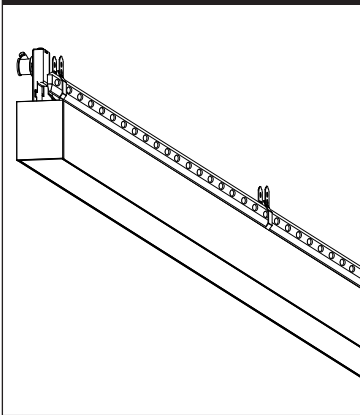

SIGN LEGEND



POWER OFF



POWER ON



ATTENTION



DON'T TOUCH THE LED



USE ESD GLOVES

TOOLS REQUIRED (not included)



pencil



drill



screwdriver



screws



anchors (appropriate for your application)

BASO 1.5 direct

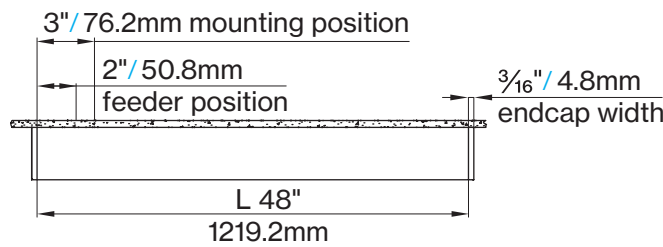
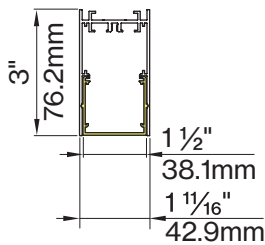

BASO 2.5 direct

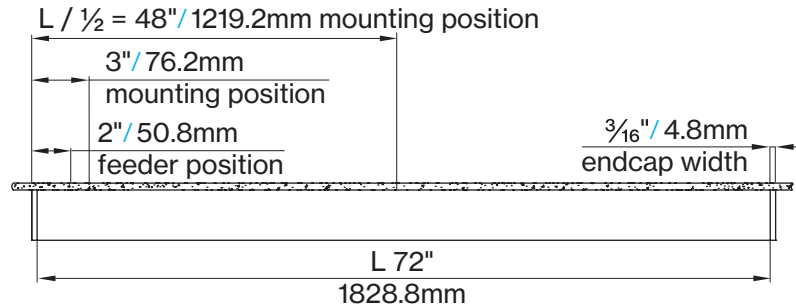
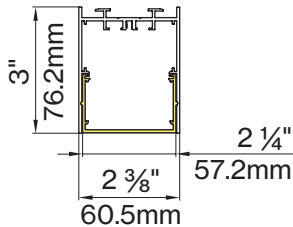

BASO 4.0 direct

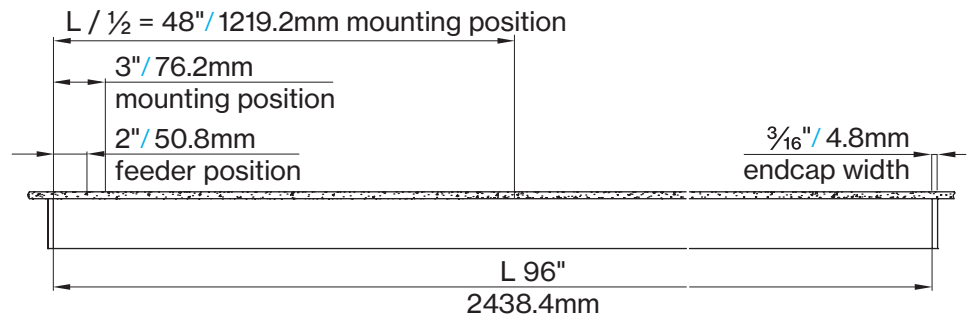
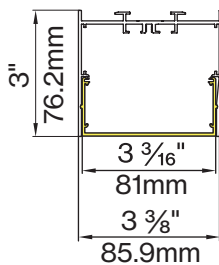

TURN OFF POWER SOURCE BEFORE INSTALLATION

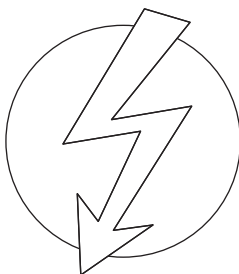

1. Remove inset from channel

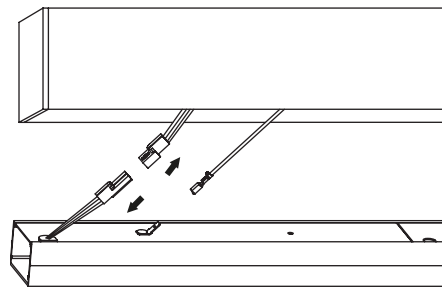

2. Screw in the T-BAR clip at all three openings in the channel.

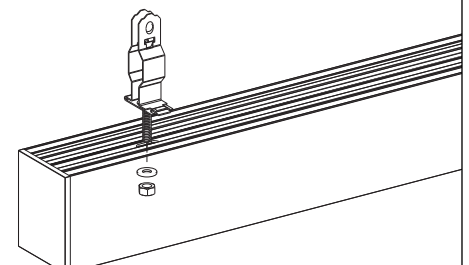

BASO 1.5 / 2.5 / 4.0 T-BAR GRID surface

MOUNTING INSTRUCTIONS

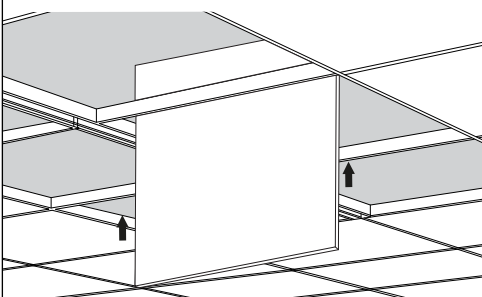
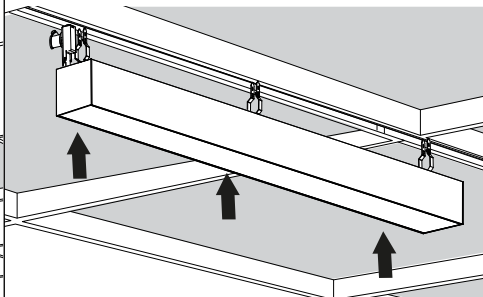
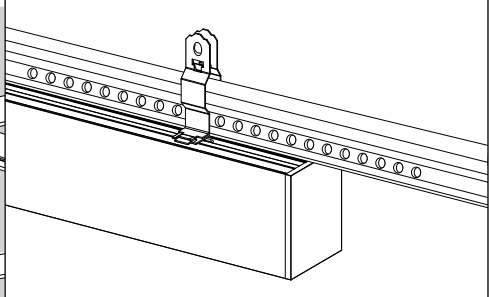
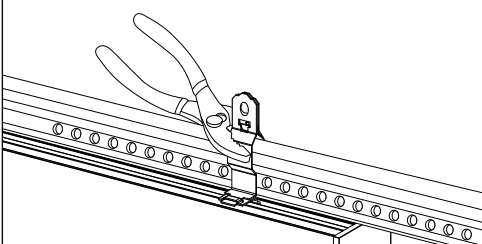
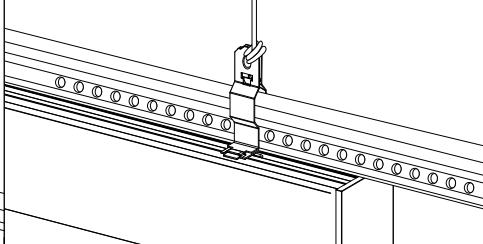
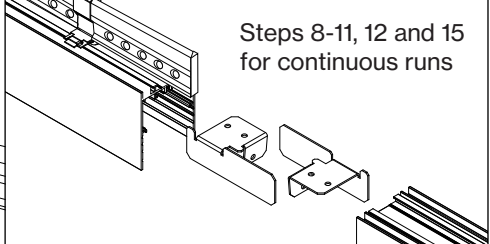
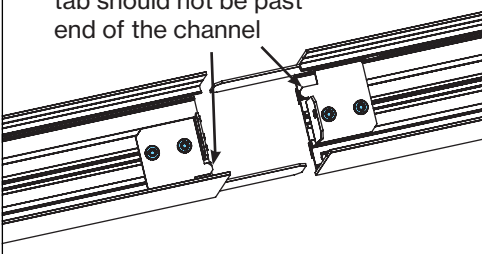
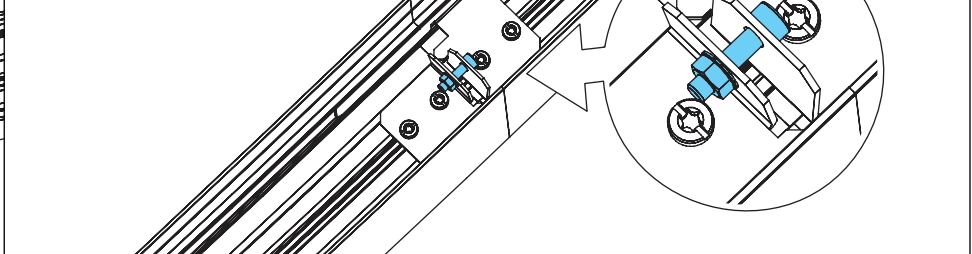
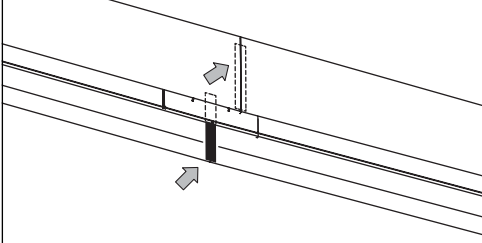
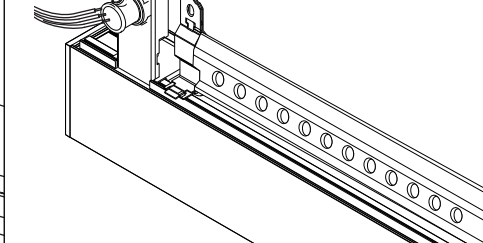
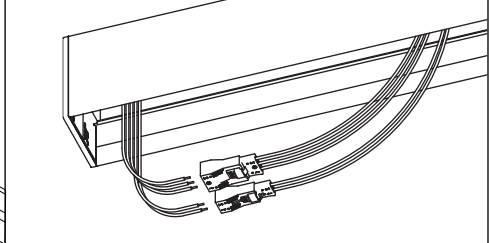
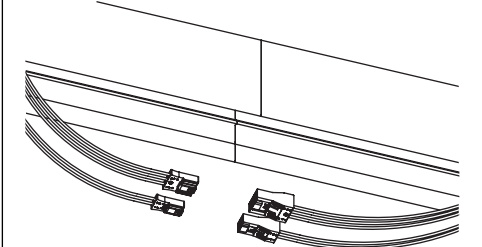
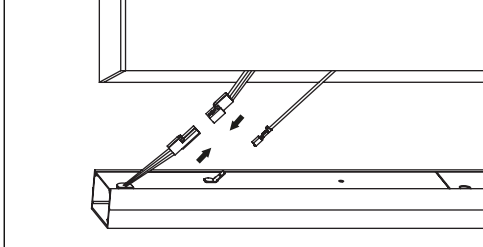
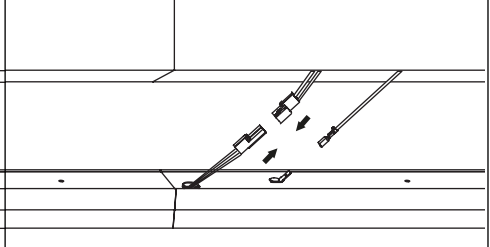
| | | |
|---|--|---|
| <p>3. Remove surrounding ceiling tiles</p>  | <p>4. Align the channel with T-BAR section</p>  | <p>5. Attach the T-BAR clip to the T-BAR section</p>  |
| <p>6. Secure the clip by clamping the octagonal opening to the T-BAR with pliers</p>  | <p>7. Optional: Secure the two sides of all T-BAR clips with suspension cables and attach to the structure above ceiling.</p>  | <p>8. SYSTEMS: Slide connectors into channels</p>  <p>Steps 8-11, 12 and 15 for continuous runs</p> |
| <p>9. SYSTEMS: Use screws to secure connectors to channels</p> <p>tab should not be past end of the channel</p>  | <p>10. SYSTEMS: Slide channels together. Secure connectors with screw and nut</p>  | |
| <p>11. SYSTEMS: Apply black electrical tape to the interior of the channels (where channels meet)</p>  | <p>11. Thread power cables through the power feeder clip</p>  | <p>12. Establish primary connection to feeder</p>  |
| <p>13. SYSTEMS: Establish connection between segments. Repeat steps for multiple channels.</p>  | <p>14. Connect inset(s) wiring, grounding clip and fall protection to channel(s)</p>  | <p>15. SYSTEMS: Make connection between segments</p>  |

BASO 1.5 / 2.5 / 4.0 T-BAR GRID surface

MOUNTING INSTRUCTIONS

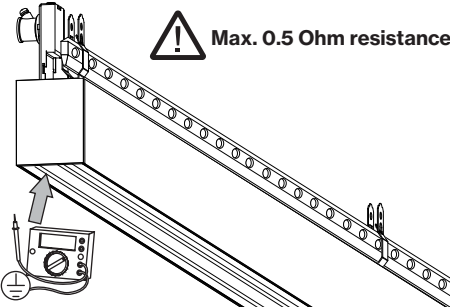
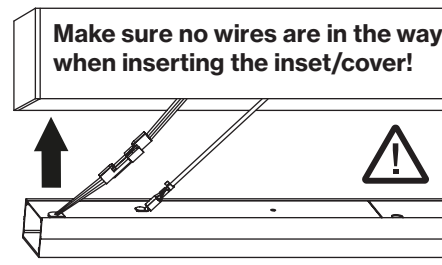
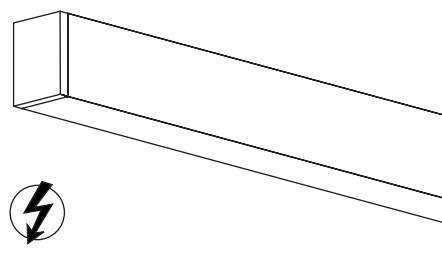
| | | |
|--|--|--|
| <p>16. Test the current</p>  <p>Max. 0.5 Ohm resistance</p> | <p>17. Insert inset/cover into channel</p>  <p>Make sure no wires are in the way when inserting the inset/cover!</p> | <p>18. Installation complete</p>  |
|--|--|--|

IMPORTANT:
Cover must sit flush. If cover does not sit flush and is not fully engaged, it might fall. Due to changes in temperature, the acrylic can slightly shrink and expand.

As long as they are installed correctly, the lighting fixtures are designed to accommodate those physical changes.

WRONG

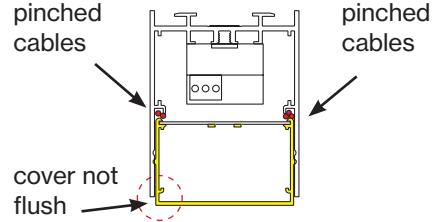

pinched cables

cover not flush

pinched cables

IMPORTANT:
Quick connectors must be tucked in between drivers and open space in the fixture. Make sure quick connectors don't rest on the LED board.

WRONG

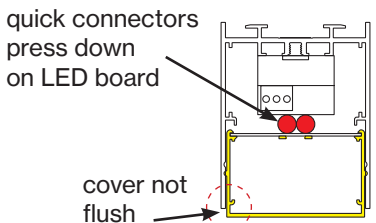

quick connectors press down on LED board

cover not flush

RIGHT

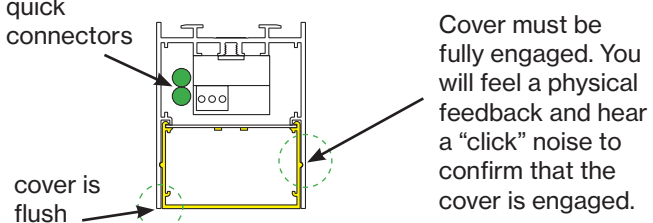

quick connectors

cover is flush

Cover must be fully engaged. You will feel a physical feedback and hear a "click" noise to confirm that the cover is engaged.

BASO 1.5 / 2.5 / 4.0 T-BAR GRID surface

MOUNTING INSTRUCTIONS

Technical Support Hotline

Call the Technical Support Hotline from
Monday to Friday, 8 AM - 6 PM (EST)

Hotline:
+1 203 262 9990

Or 24/7 via email:
service@basolighting.com

EN Installation, commissioning and maintenance may only be performed by authorized and qualified personnel, taking into consideration these installation instructions and any standards and regulations applicable to the respective area of application. The electrical, mechanical and thermal suitability of the luminaire for the intended area of application must be ensured and the secure fastening of the luminaire after its installation must be controlled. Turn off supply voltage before replacing any lamps (if applicable) as well as before performing any other works on the luminaire (e.g. cleaning) and wait until luminaire and lamp have completely cooled off. Please refer to the installation notes of the lamp manufacturer when inserting, replacing and operating conventional lamps. Use a soft, damp cloth to clean the luminaire. To clean plastic components and reflectors, a standard pH neutral, alcohol-free, non-abrasive cleaning agent may also be used.

Keep these installation instructions in a safe place as reference for any future maintenance works.

1. The lamp is not suitable for outdoor use.
2. The lamp may only be used with a safety guard.
3. Damaged protection glasses and covers have to be replaced immediately.
4. Corrosive chemical products must not be used as this may have a detrimental effect on the luminaire.
5. No liability is accepted for any subsequent change of the luminaire.
6. LEDs are high-quality electronic components! Please avoid touching by hand the LED light emitting surface while assembling or replacing parts and during maintenance work.
7. To avoid damage of the profile, unevenness on the wall or ceiling must be leveled out before assembling the profiles. While assembling the profiles, make sure they do not deform in order to guarantee their proper function.
8. The light source contained in this luminaire shall only be replaced by the manufacturer or his service agent or a similar qualified person.
9. The LED circuit must always be closed, before the converter is connected to the main power. BASO does not assume any liability for damages resulting from nonobservance of this rule.
10. Luminous flux and connected electrical load are subject to an initial tolerance of up to +/-10%. Color temperature is subject to a tolerance of up to +/- 150 Kelvin from the nominal value.

ES Le montage et la maintenance peut être effectuée par spécialistes respectant les normes y régles valides. Assurer l'aptitude thermique, mécanique et électrique pour l'emploi prévue et assurer la fixation de la luminaire. Éteindre la tension avant de changer les lampes (si applicable) ou avant de réaliser travaux (p.ex nettoyage) a la luminaire. Attendre jusqu'à ce que la luminaire et les lampes ont fraichit completement. Merci de bien vouloir vous référer aux notes d'installation du fabricant de la lampe lors de l'insertion, le remplacement et la mise en route, avec des lampes conventionnelles. Pour nettoyer la luminaire utiliser un drap humide et doux. Pour nettoyer les parties du plastique ou les reflecteurs on peut utiliser encore un produit de nettoyage sans alcool qui ne fraye pas le material. Garder cette notice de montage pour possibles travaux de maintenance.

1. La luminaria n'est pas apte pour l'utilisation exterieur.
2. Utiliser la luminaria seulement avec un dispositif de sécurité.
3. Changer immédiatement des verres de sécurité defectes ou bien des écrans de protection.
4. Evitez tout contact de la lampe avec de produits chimiques corrosifs.
5. Nous déclinons toute responsabilité en cas de modifications ultérieures.
6. Des LEDs sont des composants électroniques de haute qualité! Eviter tout contact direct de la surface de sorti de lumière de la LED avec les mains lors du montage ou des les travaux de maintenance de la lampe.
7. Pour éviter l'endommagement du profil, il est nécessaire de compenser les irrégularités du mur ou du plafond avant le montage des profils. Pour garantir un fonctionnement irréprochable des profils, il ne faut pas déformer les profils lors du montage.
8. La source du luminaire peut être remplacé uniquement par le fabricant ou un tiers habilité.
9. Il faut que le circuit de LED soit fermé avant de connecter le convertisseur. BASO ne assume pas la garantie si cette norme ne se respecte pas.
10. La puissance et le flux lumineux affichent d'origine une tolérance de +/-10 %. Tolérance de la couleur de température : +/- 150 Kelvin.

FR La instalación, la puesta en marcha y el mantenimiento sólo deben realizarse por personal especializado considerando esta guía de instalación y todas las normas y reglamentaciones vigentes. Asegurarse de la aptitud eléctrica, mecánica y térmica de la luminaria para la aplicación prevista y comprobar la fijación segura de la luminaria después de su instalación. Apagar siempre la corriente antes de cambiar la lámpara (en caso justificado) o de realizar algún otro trabajo en esta (p.ej. Limpieza). Esperar hasta que se enfrien la luminaria y la lámpara completamente. Tener en cuenta las instrucciones de montaje del fabricante al colocar, cambiar y utilizar lámparas convencionales. Para la limpieza de la luminaria utilizar un paño suave y húmedo. Para limpiar componentes de plástico y reflectores puede usar también un limpiador pH neutral y sin alcohol que no roce el material. Guardar esta guía de instalación para trabajos de mantenimiento.

1. La luminaria no es apta para utilizarla en el exterior.
2. La luminaria solo debe accionar con un dispositivo de seguridad.
3. Cambie de inmediato los vidrios y las tapas de protección dañados.
4. Químicos que tienen efectos corrosivos no deben intuir en la luminaria.
5. Para modificaciones futuras en la luminaria no se asume ninguna responsabilidad.
6. Los LED son componentes electrónicos de alta calidad! Por favor durante el montaje o el mantenimiento evite el contacto directo con la superficie de emisión.
7. Para evitar danos en el perfil, los desniveles de las paredes y techos deben ser enrasados antes del montaje de los perfiles. Para garantizar su buen funcionamiento, los perfiles no deben sufrir deformaciones durante el montaje.
8. La fuente luminosa contenida en esta luminaria debe ser reemplazada únicamente por el fabricante o su agente de servicio o similar persona cualificada.
9. El circuito LED debe ser cerrado antes de conectar el convertidor. BASO no asume garantía si esta norma no se respeta.
10. I dati di flusso luminoso e potenza sono inizialmente passibili di tolleranze di +/- 10%. Tolleranza della temperatura di colore: +/- 150 Kelvin.

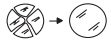

The lamp may only be operated with its full protective cover!

L'apparecchio necessita del relativo vetro di protezione!



Sólo usar la luminaria con su cobertura de seguridad completa!

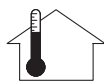

Recommended room temperature: 77 °F.

Temperatura ambiente recomendada: 77 °F.

Température ambiante recommandée: 77 °F.



Don't touch the LED



Use gloves.

Use guantes.

Utiliser des gants.